

Foreword

Manual instruction

Thanks for purchasing our UPS, it is safe and reliable, so few maintenance is required.

Read this manual carefully and completely. It includes instructions of safety installation and operation. They will help your UPS obtain the longest life and service. This manual accounts the internal working principle and the relative protection functions. This manual also contains information about the usage of the equipment.

Please obey the instructions and all the warning stated in the manual or on the machine. Don' t operate the machine before finishing reading the safety and operation instructions.

Note: Because of the continuous improvements, our products may differ somewhat from the contents included in this manual. You can contact local office to get the information when necessary.

Content

1. Summary.	2
1.1 Introduction.....	2
1.2 functions and characteristics	2
2. Safety instruction	4
2.1 Safety instruction.....	4
2.2 Symbols indication.....	5
3. Product Introduction	6
3.1 The appearance of the product	6
3.2 The principle of the product	7
3.3 Model.....	7
4. Installation	8
4.1 Unpacking and inspection	8
4.2 Notes.....	8
4.3 UPS input connection.....	8
4.4 UPS output connection.....	9
4.5 Long backup external battery connection.....	9
4.6 Installation.....	10
5. Faceplate display, operation and running.....	13
5.1 Faceplate display illumination	13
5.2 Operation.....	16
5.3 Parameter setting.....	17
5.4 Parameters inquiring.....	21
5.5 Run mode.....	23
6. Maintenance	25
7. Troubleshooting and properties of product.....	26
7.1 LED indication and warning table	26
7.2 Troubleshooting.....	28
7.3 EMC standard/Safety standard	29
7.4 Product Performance	29
7.5 Communication interface	30

1. Summary

1.1 Introduction

UPS (uninterruptible power supply) is a kind of power supply equipment that provides uninterruptible, high quality and efficient and reliable AC power to the loads, it also has functions of protection and monitoring. The UPS plays a very important role in power supply of computer and its network, communication, finance, electricity, transportation, national defense, college, scientific research institutes and so on.

This series of RT 1250VA(S/H), RT 2000VA(S/H), RT 3000VA(S/H) products are designed as advanced ON-LINE UPS that provide the multiple functions and good performance.

1.2 functions and characteristics

1. Advanced IGBT modules are used in our UPS. The electronic components we used can work normally for more than 300,000 hours.

2. Digital control technology with high efficiency and the most reliable controller algorithm design are used to optimize the output parameters of the machine.

3. Self-diagnose before start. It can find potential problems of the UPS in time to avoid any losses.

4. Double conversion on-line topology which makes the output of the UPS a pure sine wave electricity with constant frequency and voltage, low noise and no interruption of the main power fluctuation. It provides more comprehensive and perfect protection for the users' equipments.

5. No transfer time for the output of the UPS when the main power fails or restores. It meets the high standard and high request of the precise instruments.

6. The bypass function. When UPS meets a fault, it can transfer to bypass with no interruption to supply power to loads and provide alarm.

7. Advanced voltage compensation technology. It makes the input voltage range from 115v to 295v which reduces the battery usage and enhances the adaptive ability against the bad main power variation.

8. The AC input frequency is 50Hz/60Hz. Advanced wide frequency input technology makes the input frequency range wider. When the output frequency is 50Hz, the range of the AC input frequency is 45Hz-55Hz, When the output frequency is 60Hz, the range of the AC input frequency is 55Hz-65Hz. The UPS has a good compatibility with generator. It is suitable for different types of single-phase generators.

9. The advanced PFC (power factor correction) technology on the input of the UPS makes the input power factor more than 0.98. It increases the power efficiency, removes the harmonic noise from UPS to utility, lowers the UPS operational cost. It's really an economic environmental protection power supply.

10. Intelligent function without surveillance. When main power is on blackout, the UPS will start battery mode to supply power to loads.

When battery voltage is low, UPS will protect itself and shut down automatically. When main power restores, UPS will detect main power

to determine whether the voltage and frequency are normal. If normal, UPS will turn on automatically to supply power to loads; if abnormal, UPS will start charger to charge the battery. The UPS will not turn on to supply power to loads until the voltage and frequency of the main power restore normally.

11. Cold start function. When there is no main power, UPS can be started by battery pack. It can meet the users' emergency needs. The cold start function is quite strong. UPS can be cold started under the full load situation.

12. UPS protection function:

When the main power input/output voltage is too high or too low, overload, short-circuit, inverter temperature is too high, low voltage

and overcharge of battery, network surge and so on, UPS has a protection function.

13. Rack-Tower conversion LCD design. No matter what angle to watch the display, only press the key slightly can meet your perspective needs. The content displayed on the interface is rich. The capacity of the loads and the battery can be saw directly and the FLASH pictures and fan rotating icon can be displayed when charging. So it is easy to know it's operation. When UPS fails, it can show the fault code, the machine can be maintained as soon as possible by inquiring fault code table.

14. The UPS can communicate with the computer with intelligent UPS monitoring software through the RS232 interface. All the parameters clearly display on the communication interface. Computer can control multiple functions of the UPS directly.

15. Via internal or external SNMP adapter, UPS can go on internet and provide the latest information and power messages. You can monitor and manage the UPS status through all kinds of network management system.

16. Convenient USB communication. You can see the operation of the machine completely. Even if the RS232 interface is occupied or connected at the same time, it will automatically switch to USB connection.

17. ECO function can help you save electricity. When the input mains power is in a fixed range, the loads is supplied with power by mains power directly, the inverter is on waiting; when input mains power is abnormal, it transfers to inverter to supply power to loads at once.

18. In order to ensure the power of the important loads can last for a long time, you can plug the important loads into the second power down socket. When the battery voltage is below the predetermined value, only the first cut-off power socket is broken off, the second power down can keep on supplying power until the battery voltage reaches protect point and shut down.

19. Adopt international standard rack-mounted size. Whether you want to put it on the office desk or in the rack-mount as a system to manage, It can present your personal style with corresponding components.

2. Safety instruction

Abstract

This chapter mainly introduce the safety marks and notes of RT 1250VA(S/H), RT 2000VA(S/H), RT 3000VA(S/H) series on-line UPS. Read this chapter carefully before operating on the equipment.

2.1 Safety instruction



There is dangerous voltage and high temperature inside the UPS. During the installation, operation and maintenance, please abide the local safety instructions and relative laws, otherwise, it will result in personal injury or equipment damage. Safety instructions in this manual act as a supplementary for the local safety instructions.

Our company will not assume the liability that caused by disobey of safety instructions. Please note the following:

1. Don't use the UPS when the actual load exceeds the rated load.
2. There are high-capacity batteries in the standare type UPS. You mustn't open the enclosure or it will lead to electric shock. If it needs internal maintenance or battery replacement, please send it to the designated site.
3. Internal short-circuit of the UPS will cause electric shock or fire. So don't place the containers equipped with liquid on the top of the UPS so as not to cause danger of electric shock and so on.
4. Don't put the UPS in a place with high temperature or humidity as well as the corrosive gas, much dust.
5. Keep good air circulation between in-vent on front panel and out-vent on back panel.
6. Avoid direct sunlight or near heat-dispensed objects.
7. In case that the smoke appears on the UPS, please cut off the power as soon as possible and contact the dealer service site.

2.2 Symbols indication

The safety symbols cited in this manual are shown in table 1-1, which are used to inform readers of safety issues that should be obeyed when installation, operation and maintenance.

Safety Symbol	Indication
	Attention
	Static discharge sensitive
	Electric shock

There are three levels of safety grade: Dangerous, Warning and Attention. The remark is on the right side of the safety symbol, the detailed comments is behind, shown as following:



Dangerous

Indicate risk of serious injury or death or seriously damage the equipment



Warning:

Indicate risk of serious injury or damage the equipment.



Attention:

Indicate risk of injury or damage the equipment.

3. Product Introduction

3.1 The appearance of the product

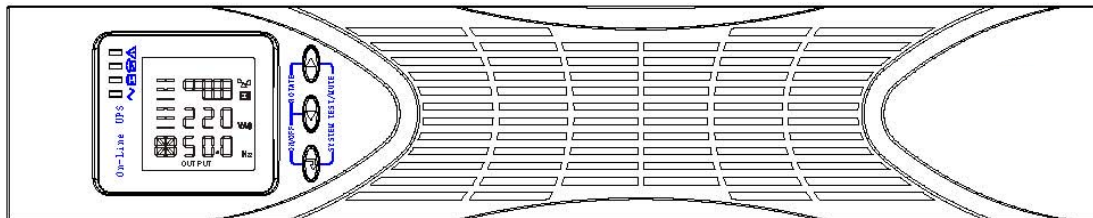

Fig 1 Front Panel view

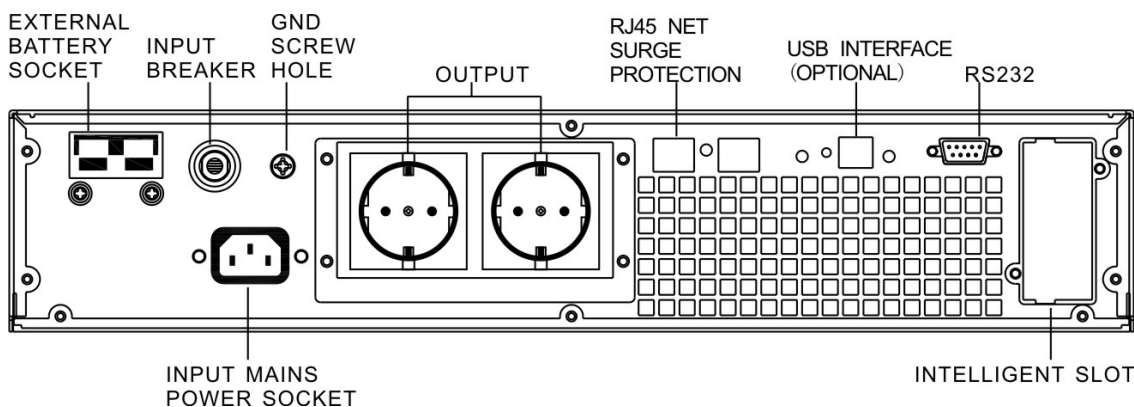

Fig 2 RT 1250VA Rear Panel view

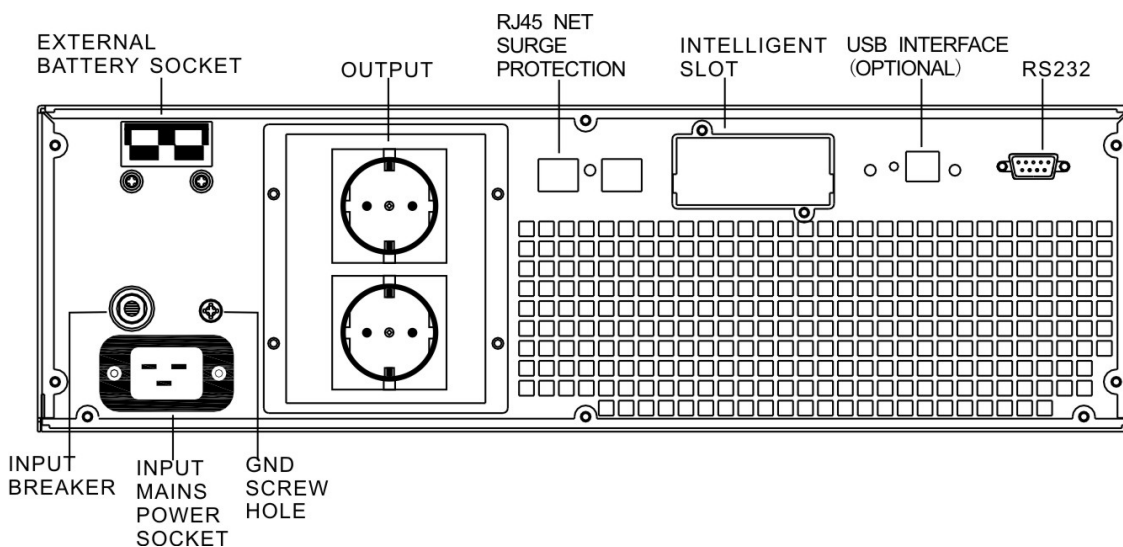

Fig 3 RT 2000VA/RT 3000VA Rear Panel view

3.2 The principle of the product

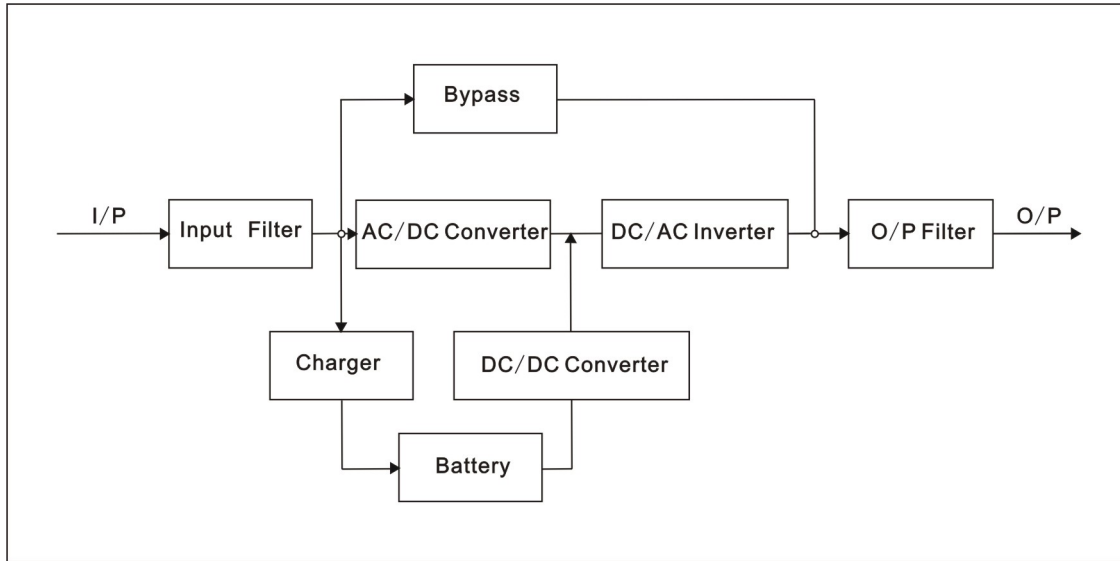

Fig 4 UPS Principle Diagram

1. input filter: Complete filtering the input AC utility power to provide the clean power for UPS.
2. AC/DC converter: Convert the filtered AC mains to DC and boost the DC for DC/AC inverter.
3. DC/DC booster: When the UPS works in battery mode, the circuit boosts the DC for DC/AC inverter.
4. DC/AC inverter: Convert the boosted DC to stable AC output.
5. Bypass: When overload or failure of inverting happen in the UPS, it transfers to bypass mode to supply power to loads.
6. Charger: Standard unit provides 1A; long backup unit provides 7A/14A.
7. Battery: Sealed Lead Acid Battery.
8. Output filter: Complete filtering the output of the UPS to provide the clean power for loads.

3.3 Model

UPS sort	MODEL NO	Remark
Standard unit	RT 1250VA	Internal 1A charger, 2 high-rate 9AH batteries
	RT 2000VA	Internal 1A charger, 4 high-rate 9AH batteries
	RT 3000VA	Internal 1A charger, 2 high-rate 9AH batteries
Long backup unit	RT 1250VA(H)	★internal 7A/14A charger, external 24V battery
	RT 2000VA(H)	★internal 7A/14A charger, external 48V battery
	RT 3000VA(H)	★internal 7A/14A charger, external 72V battery

Notice: long backup unit can choose two chargers connected in parallel, the charger current is 14A.

4. Installation

4.1 Unpacking and inspection

1. Unpacking the UPS and check that whether it' s damaged during the transportation. If damaged or some parts missing, don' t start the machine and inform the carrier and franchiser.
2. Check the annex (please consult Appendix Table 1).
3. Check if the equipment is just what you wanted to purchase. You can affirm through inspecting the model number on back panel of the equipment.

4.2 Notes

1. Please place the UPS in a clean, stable environment, avoid the vibration, dust, too humidity, flammable gas and liquid, corrosive.
2. The ambient temperature around UPS should keep in a range of 0°C ~ 40°C. If UPS works above 40°C, it is required that the rated value of the largest load decreases 12% while the temperature increases the 5°C every time. The highest temperature cannot be more than 50°C when UPS works.
3. UPS should be placed in a sufficiently ventilated place.

4.3 UPS input connection

Connect the UPS to the mains by input power cable which is equipped with the UPS.

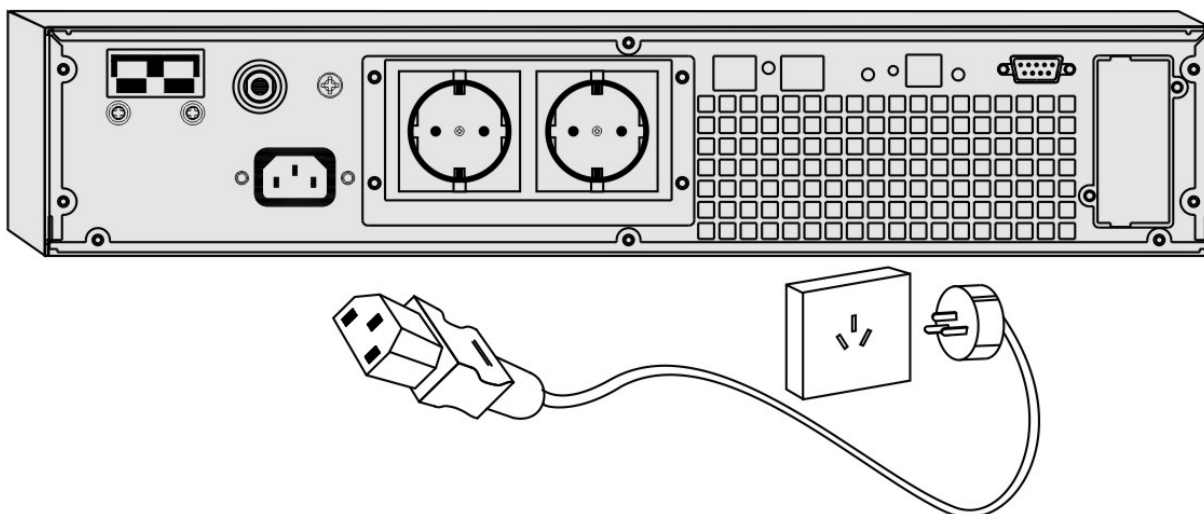

Fig 5 Input Connection

4.4 UPS output connection

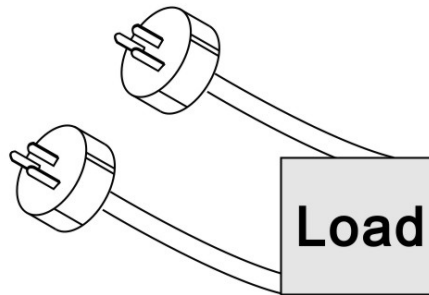
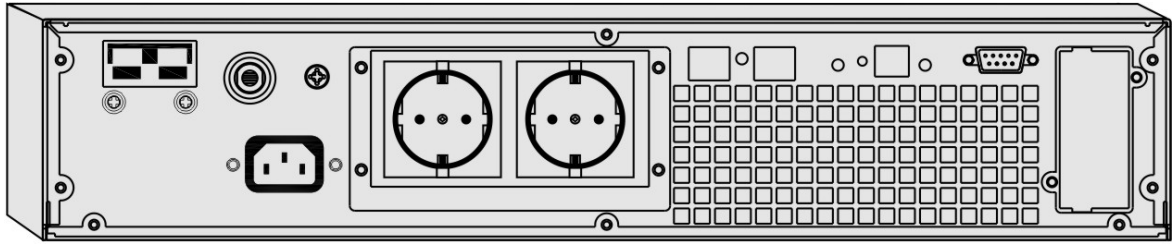

Fig 6 output connection

4.5 Long backup external battery connection

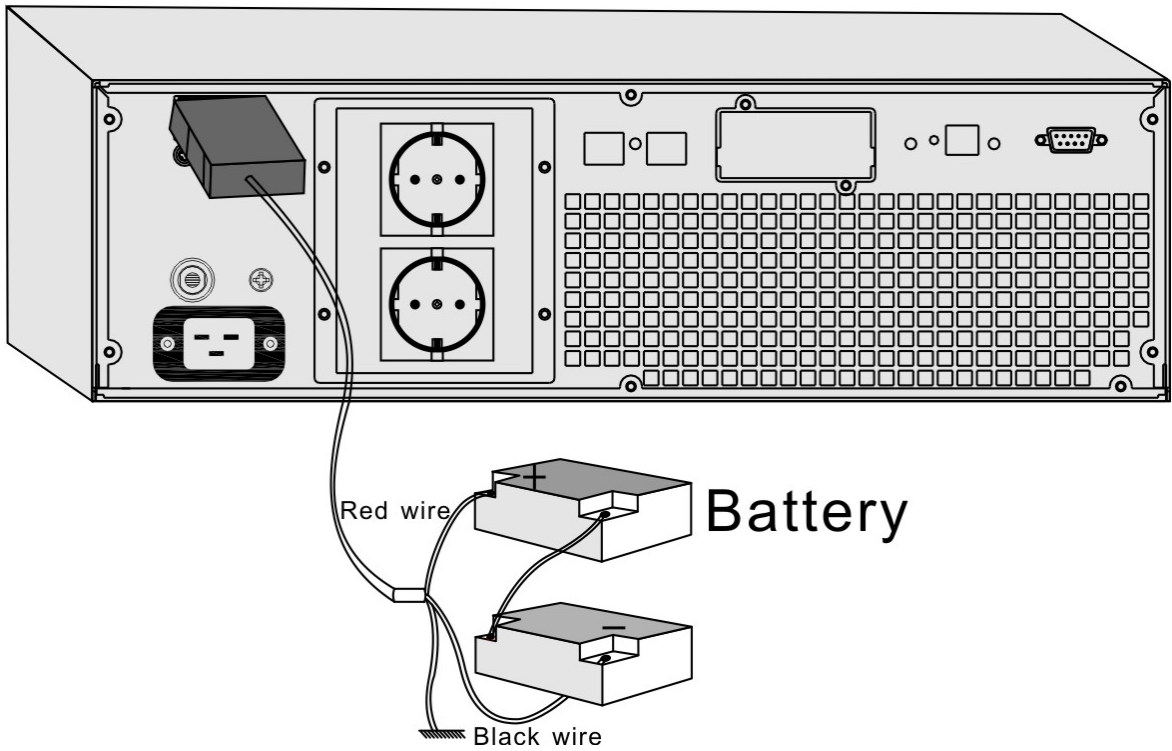

Fig 7 battery connection

4.6 Installation

4.6.1 Plastic base installation

① two plastic base brackets intercross as following Figure

② flatten it after intercrossing

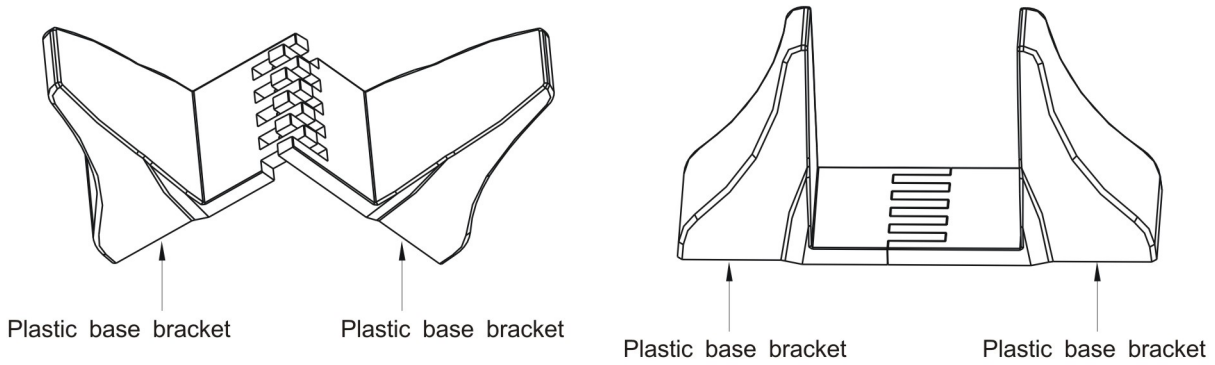

Fig 8 RT 1250VA(S/H) plastic base assembly

③ RT 2000VA/RT 3000VA(S/H) plastic base assembly is similar to RT 1250VA(S/H), the difference is that there is a 1U plastic base bracket extended board for RT 2000VA/RT 3000VA(S/H)。

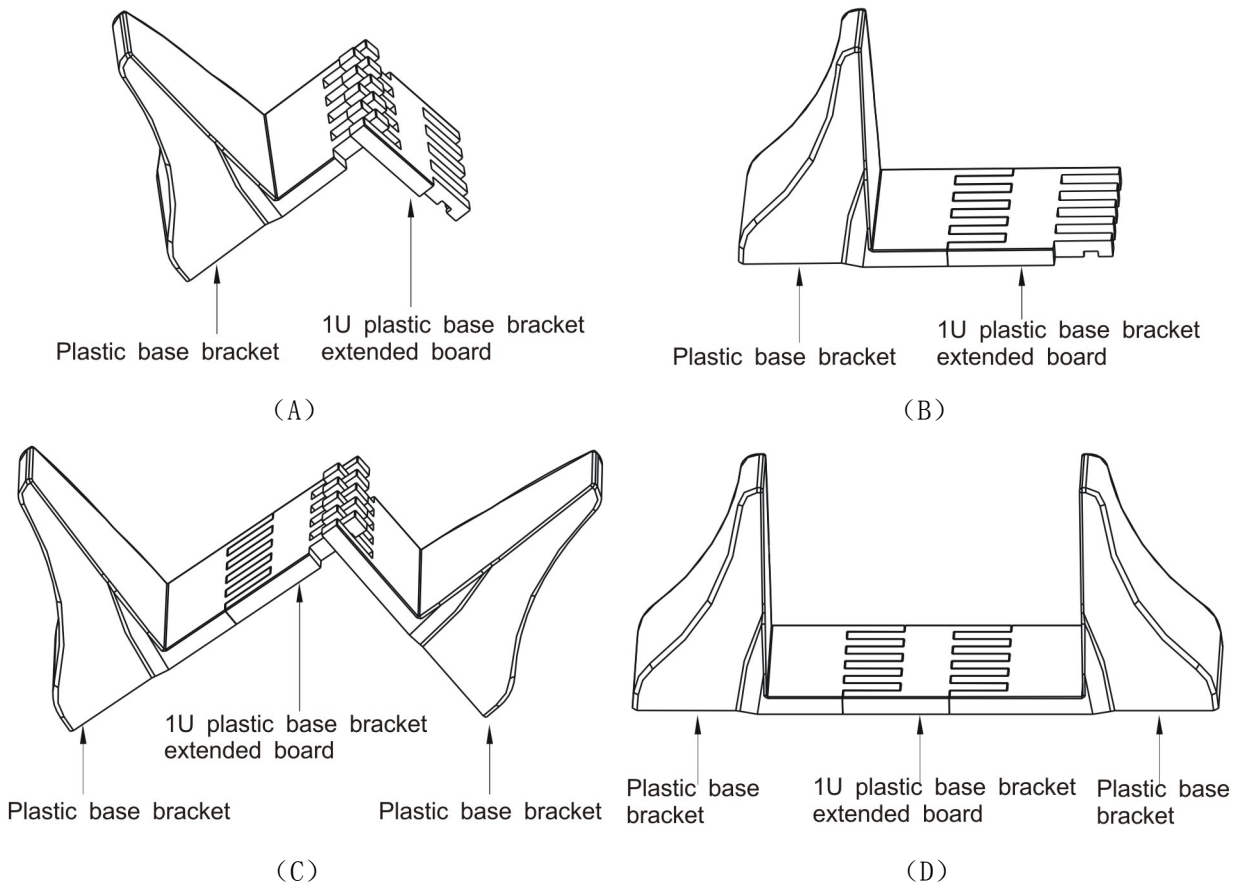

Fig 9 RT 2000VA/RT 3000VA(S/H) plastic base bracket

4.6.2 Cabinet installation bracket assembly

- ① screw A, screw B, two M4 screws (symmetrical on both sides, a total of four)

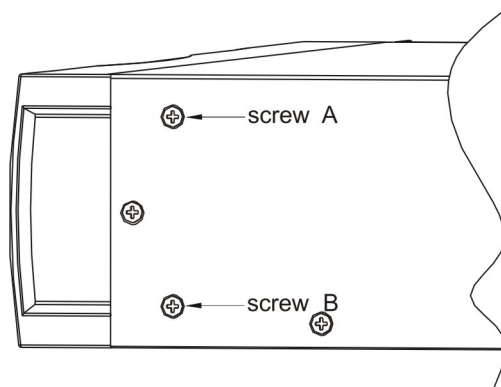

Fig 10 Cabinet installation bracket assembly

- ② cabinet installation bracket screw hole A, screw hole B are respectively corresponding to two screws (symmetrical on both sides, a total of four).

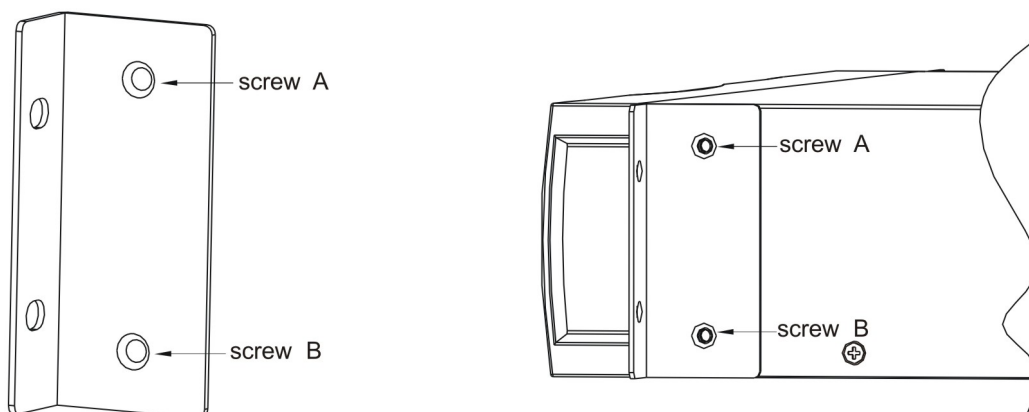

Fig 11 Cabinet installation bracket Fig 12 Cabinet installation bracket assembly

- ③ screw the two M4 screws described as Fig 10 (symmetrical on both sides, a total of four).

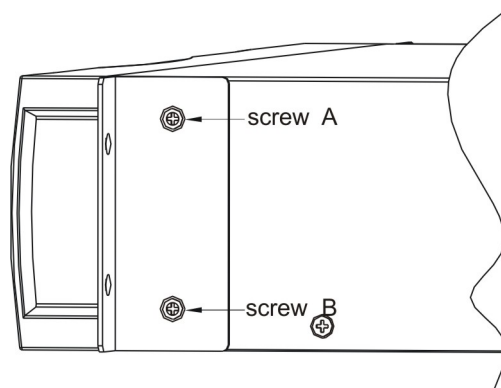

Fig 13 Cabinet installation bracket assembly

4. 6. 3 Tower/Rack assembly

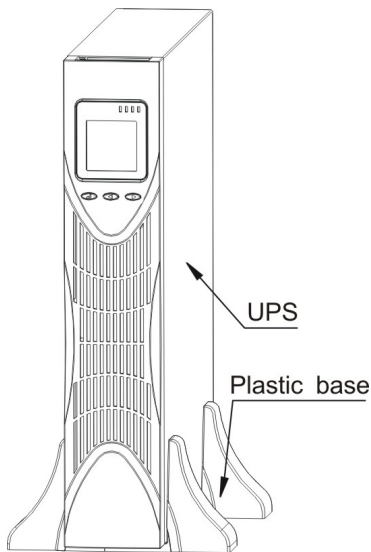

Fig 14 Tower—mounted assembly

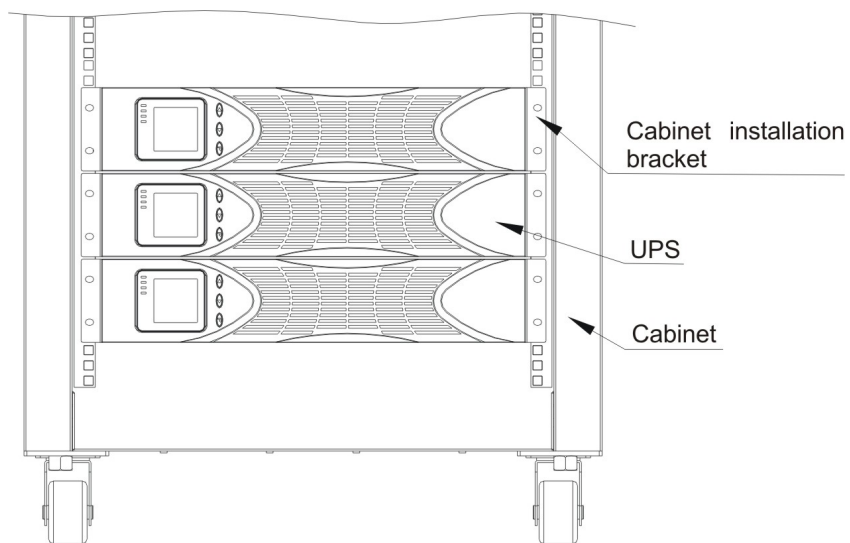

Fig 15 Rack—mounted assembly



Warning:

- ★ Before installing battery, make sure that UPS and breaker are all turned off. Remove all your metallic adornment such as finger ring, watch, and so on before connecting battery.
- ★ No anti-connection or short circuit between the battery anode and cathode forever. Red cable connect with battery anode “+” and black cable connect with cathode “-”.
- ★ Please use the screwdriver with insulating handle. Do no lay the tools or metallic goods on the battery.



Notice:

- ★ When using the external battery, It is best to use external battery cable which matches with the equipment.
- ★ When connecting load to UPS, first turn off load and then connect the power cable and finally turn on load one-by-one.
- ★ Inductance loads such as motor, fluorescent lamp, copy cat are strictly prohibited connecting to UPS to avoid damage.
- ★ Plug UPS on the special socket with over-current protection, the power socket that used should be connected with ground wire.
- ★ UPS is likely to have output voltage no matter whether the power input cable is plugged in mains input socket. If you wish UPS have no output, first break off the switch and then cancel the mains.
- ★ When connect laser printer, select the capacity of UPS according to the UPS start power because the startup power is higher.

5. Panel display, operation and running

The operation is simple, operators only need to read the manual and follow the operation instructions listed in this manual without any special training.

5.1 Faceplate display illumination

5.1.1 Keys function

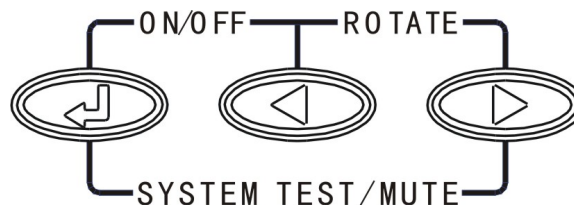

Fig 16 front panel keys instruction

┌ ON/OFF key (⏻+⏪)

Press and hold this key for more than half a second to turn on or turn off the UPS.

┌ ROTATE key (⏪+⏩)

Press and hold this key for more than 2 seconds to rotate LCD in any mode.

┌ SELF-TEST/MUTE key (⏻+⏩)

Press and hold the key for more than 1 second in mains mode or economical mode: UPS runs the self-test function.

Press and hold the key for more than 1 second in battery mode: UPS runs the mute function.

┌ INQUIRING key ⏪ or ⏩

Non-functional setting mode:

Press and hold the key for more than half a second (less than 2 seconds): Indicate the items of the LCD item section orderly.

Press and hold ⏩ for more than 2 seconds: Circularly and orderly display the items every 2 seconds, when press and hold the key for some time again, it will turn to output status.

Functional setting mode:

Press and hold the key for more than half a second (less than 2 seconds): Select the set option.

┌ Function setting key ⏻

Non-functional setting mode:

Press and hold the key for more than 2 seconds: Function setting interface.

Functional setting mode:

Press and hold the key for more than half a second (less than 2 seconds): Affirm the set option.

5.1.2 The description of LED display lamp functions

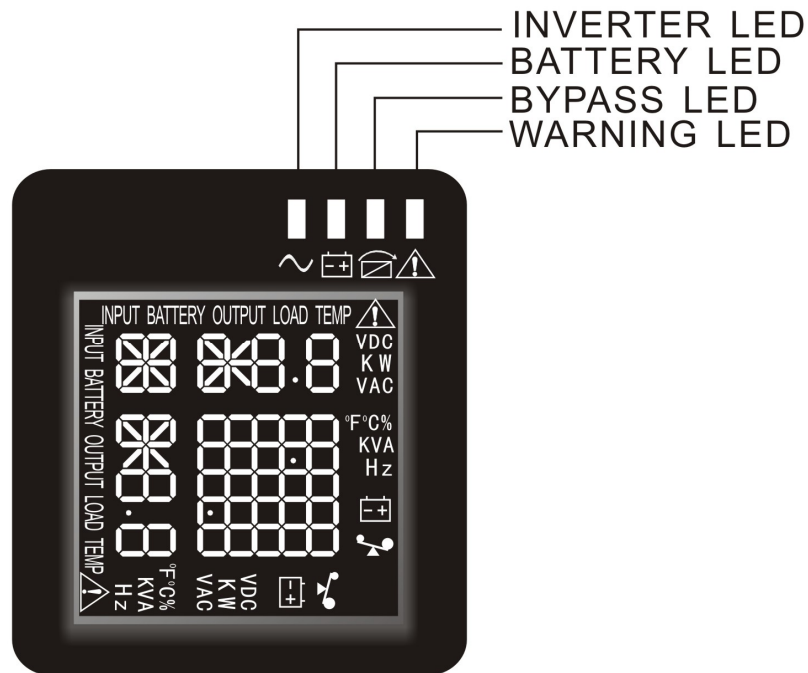

Warning red LED is on: UPS is fault and has no output. For example: Overload beyond the allowed time, inverter fault, BUS fault, over temperature fault etc.

Bypass yellow LED is on: UPS is alarming. For example: Bypass mode supply power and etc.

Battery yellow LED is on: UPS is alarming. For example: Battery mode supply power and etc.

Inverter green LED is on: UPS is normally powered by mains or ECO mode or battery mode.

After starting the UPS, the four LEDs will light and go out one-by-one. It circulates several times until starting the UPS successful.

NOTE: As to the LED indication in different modes, please refer to the LED lamps/display panel and warning table.

5.1.3 LCD display functions

When UPS is tower-mounted, the LCD displays as following Fig A. Press and hold the ROTATE key for more than 1 second, the display will begin to rotate which matches with the rack-mounted configuration. LCD displays as following Fig. B.

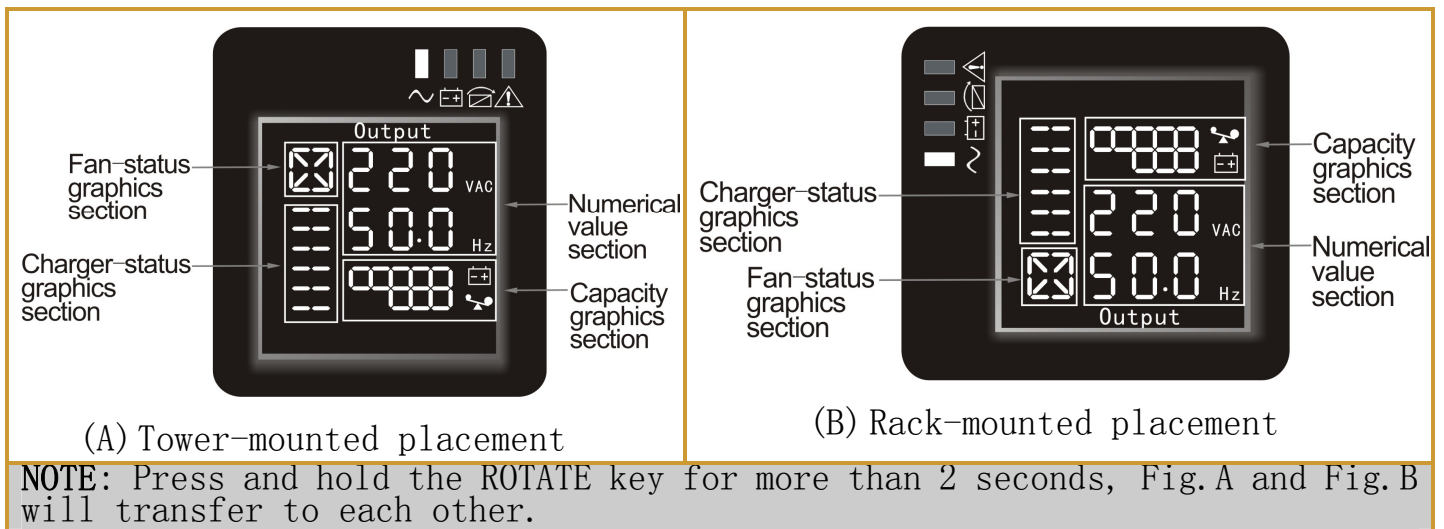

LCD display comprises numerical value section, capacity graphics section, fan-status graphics section and charger-status graphics section.

Numerical value section—display the corresponding numerical value of inquiring items(output, load, temperature, input, battery), for example, as the graphics shows above, the output voltage is 220v, the output frequency is 50Hz.

Capacity graphics section—display the capacity of the battery and load. Every pane represents 20%capacity. As graphics showed above, the capacity of the battery is 80%-100% (5 panes), the load reaches 40%-60% (3 panes). When UPS is overload, the icon will flash, when capacity of battery is too low or disconnected, the icon will also flash.

Fan-status graphics section—display if the fan works normally. When the fan works normally, it will show the dynamic fan blades rotating; when the fan works abnormally, the icon will keep on flashing and alarm.

Charger-status graphics section—display the status of the charger. When charger works normally, the corresponding icon will vary dynamically and orderly, just as Graphics (1);

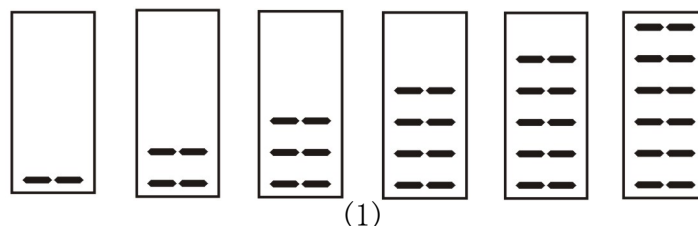

(1)

when charger works abnormally, the icon will flash in a whole, as Graphics(2):

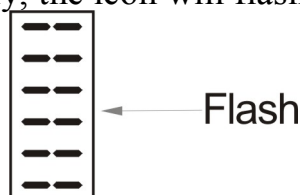

(2)

When UPS is in battery mode, the number of the icons of the charger-state section will vary according to the changeable capacity of the battery (pane). For example, there are five panes in Fig.A, (as the right picture of the Graphics(3) shows), so the corresponding number of icons is five rows (as the left picture of the Graphics(3) shows), followed by this rule,



(3)

5.2 Operation

5.2.1 Start up operation

Turn on the UPS in line mode

- ① Once mains power is plugged in, the UPS will charge the battery, at the moment, LCD shows that the output voltage is 0, which means UPS has no output. If it is expected to have output of bypass, you can set the bps “ON” by LCD setting menu.
- ② Press and hold the ON/OFF key for more than half a second to start the UPS, then it will start the inverter.
- ③ Once started, the UPS will perform a self-test function, LED will light and go out circularly and orderly. When self-test finishes, it will come to line mode, the corresponding LED lights, UPS is working in line mode.

Turn on the UPS by DC without mains power

- ① When mains power is disconnected, press and hold the ON/OFF key for more than half a second to start UPS.
- ② The operation of UPS in the process of start is almost the same as that when mains power is in. After finishing the self-test, the corresponding LED lights and UPS is working in battery mode.

5.2.2 Turn off operation

Turn off the UPS in line mode

- ① Press and hold the ON/OFF key for more than half a second to turn off the UPS and inverter.
- ② After UPS shutting down, LED go out and there is no output. If output is needed, you can set bps “ON” by LCD setting menu.

Turn off the UPS by DC without mains power

- ① Press and hold the ON/OFF key for more than half a second to turn off the UPS.
- ② When turning off the UPS, it will do self-testing firstly. LED light and go out circularly and orderly until there is no display on the panel.

5.2.3 UPS self-test/mute test operation.

- ① When UPS is in line mode, press and hold the self-test/mute key for more than 1 second, LED light and go out circularly and orderly. UPS comes to self-test mode and tests its status. It will exit automatically after finishing testing, LED resume.
- ② When UPS is in battery mode, press and hold the self-test/mute key for more than 1 second, the buzzer stops beeping. If you press and hold the self-test/mute key for one more second, it will restart to beep again.

5.3 Parameter setting



UPS has setting function. It can run the setting on any mode. After setting, it will become effective at once when meets some standards. The set information can be saved only when the battery connected and normally turning off the UPS.

The operation of setting is as following:

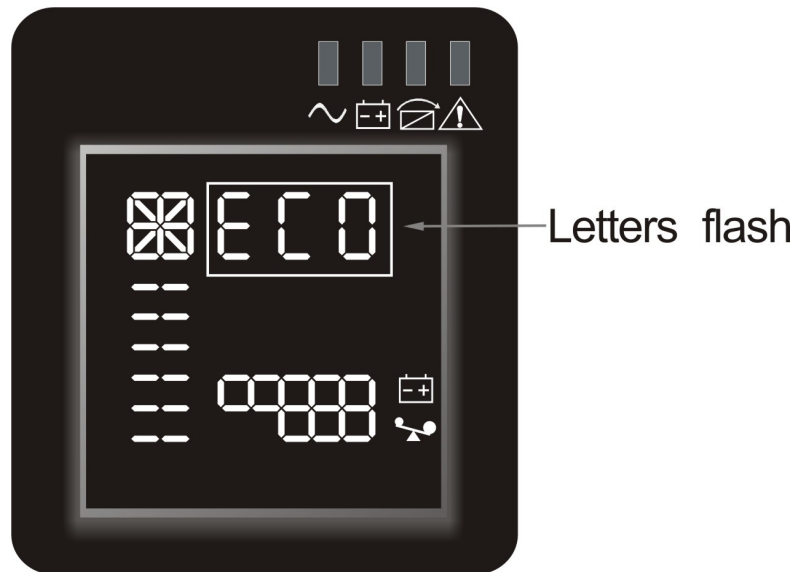

5.3.1 ECO mode setting

- ① Enter the setting interface. Press and hold the function setting key  for more than 2 seconds, then come to setting interface, the letters ECO will flash as following:



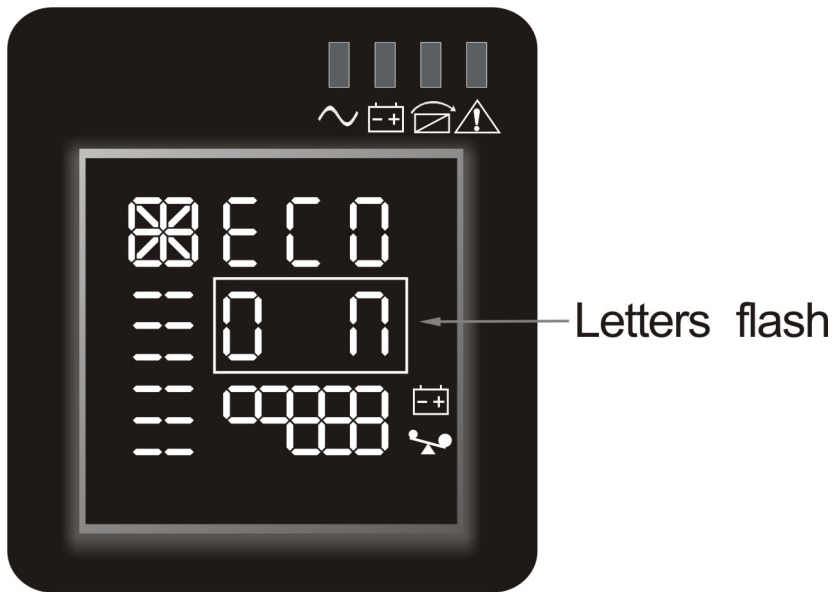

- ② Enter the ECO setting interface. Press and hold the function setting key  for more than half a second (less than 2 seconds), then come to setting interface of ECO, at this time, the letters "ECO" will light for a long time. The "ON" below the ECO will flash. Press and hold the inquiring key  for more than half a second (less than 2 seconds) to determine whether the ECO function is used or not. If used, the corresponding word is "ON", if not, the word is "OFF". It can be determined by yourself.





- ③ Confirm the ECO setting function. After selecting ON or OFF, press and hold the function setting key  for more than 2 seconds. Now, the ECO setting function is completed and the “ON” or “OFF” below the “ECO” will light without flash.
- ④ Exit from the setting interface. Press and hold function setting key  for more than 2 seconds, exit from the setting interface and turn to main interface.

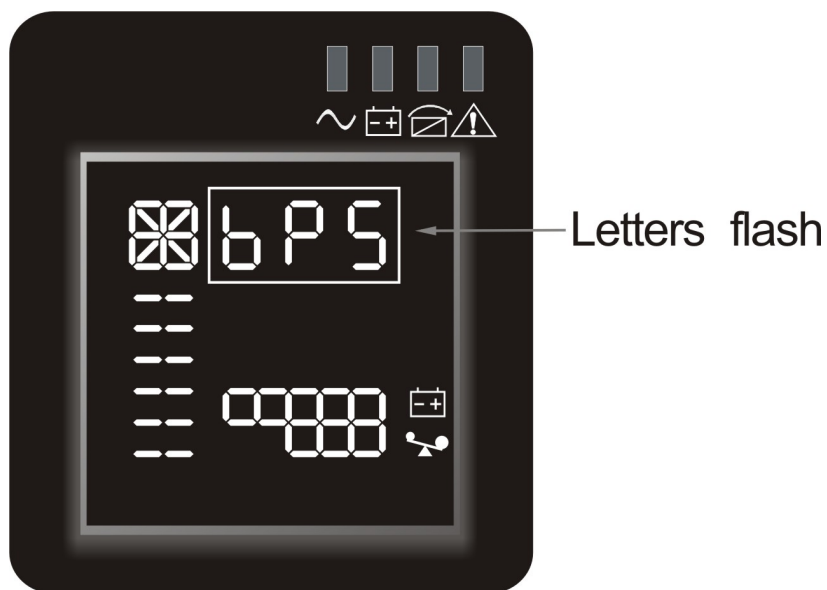

5.3.2 Bypass output setting

- ① Enter the setting interface. Press and hold the function setting key  for more than 2 seconds, then come to setting interface, Press and hold the function setting key  for more than half a second (less than 2 seconds), select the function setting, choose the bypass output interface, at the moment, the letters “bPS” will flash as following:



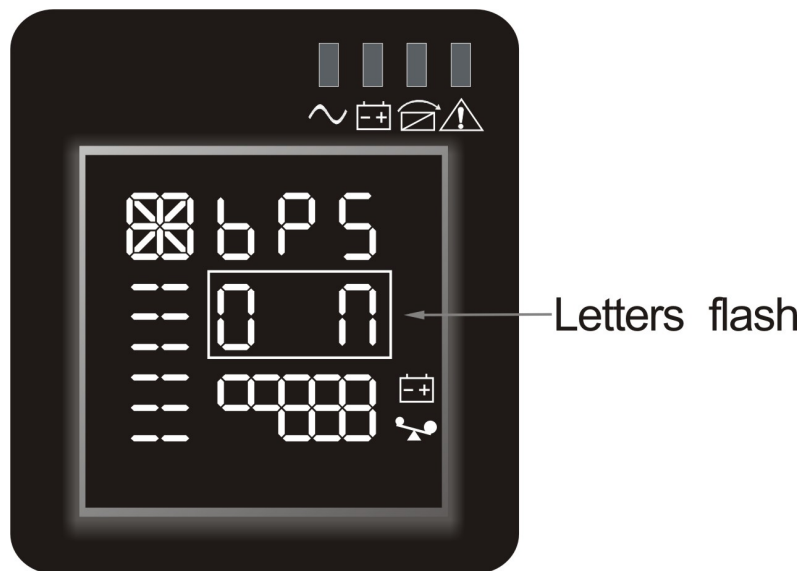

② Enter the Bypass output setting interface. Press and hold the function setting key  for more than half a second (less than 2 seconds), then come to setting interface of bPS, at this time, the letters “bPS” will light for a long time. The “ON” below the bPS will flash. Press and hold the inquiring key  for more than half a second (less than 2 seconds) to determine whether the bPS function is used or not. If used, the corresponding word is “ON”, if not, the word is “OFF”. It can be determined by yourself.





- ③ Confirm the Bypass output setting interface. After selecting ON or OFF, press and hold the function setting key  for more than 2 seconds. Now, the bPS setting function is completed and the “ON” or “OFF” below the “bPS” will light without flash.
- ④ Exit from the setting interface. Press and hold function setting key  for more than 2 seconds, exit from the setting interface and return to main interface.
- ⑤ After setting bPS as ON, when mains power plugged in without turning on the UPS or no mains power plugged in, there is bypass output but no power down backup function.

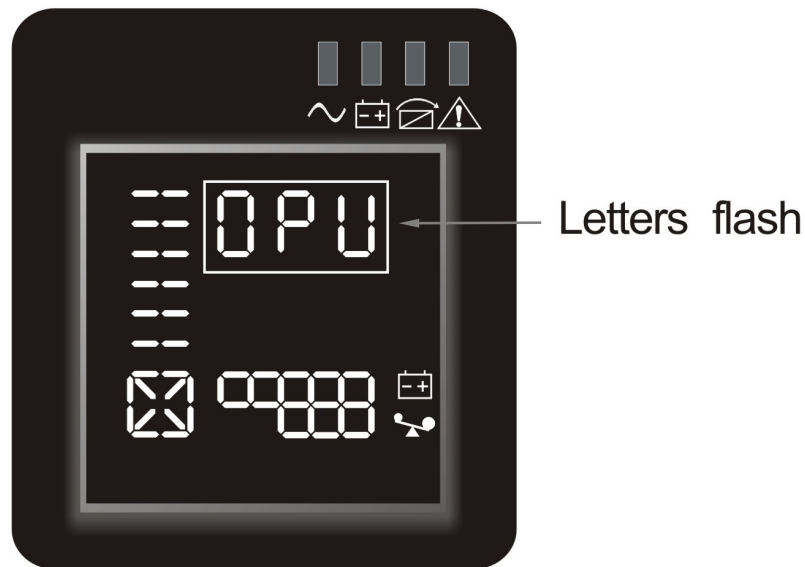

5.3.3 Output voltage setting (optional function)

- ① Enter the setting interface. Press and hold the function setting key  for more than 2 seconds, then come to setting interface, Press and hold the function setting key  for more than half a second (less than 2 seconds), select the function setting, choose the output voltage setting interface, at the moment, the letters “OPU” will flash as following:

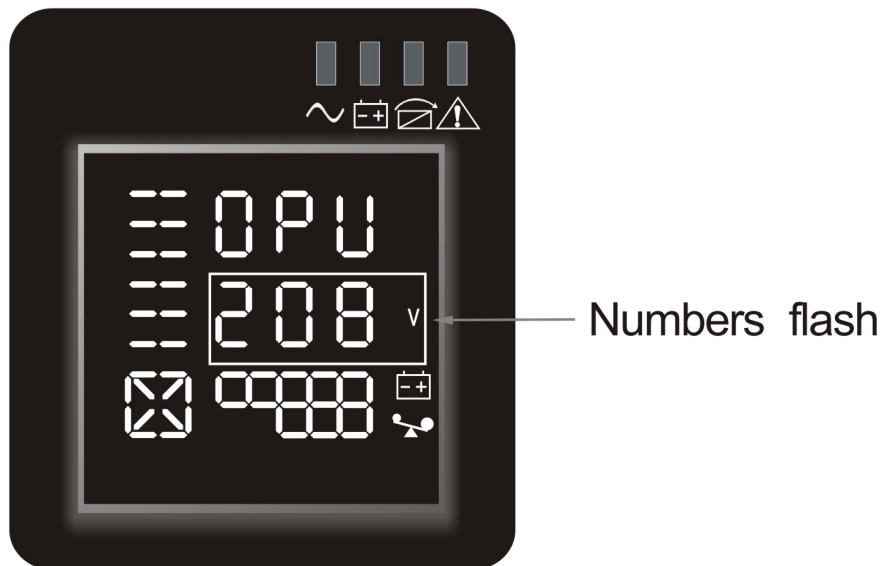

- ② Enter the output voltage setting interface Press and hold the function setting key  for more than half a second (less than 2 seconds), then come to setting interface of output voltage OPU, at this time, the letters “OPU” will light for a long time. The numerical value below the OPU will flash. Press and hold the inquiring key  for more than half a second (less than 2 seconds), select the numerical value in accordance with “OPU” function. The provided voltages are 208v, 220v, 230v, 240v you can choose anyone by yourself (The default is 220v).





- ③ Confirm the output voltage setting interface After selecting numerical value, press and hold the function setting key  for more than 2 seconds. Now, the OPU setting function is completed and the numerical value below the “OPU” will light without flash.
- ④ Exit from the setting interface. Press and hold function setting key  for more than 2 seconds, exit from the setting interface and return to main interface.



NOTE:

When setting the output voltage ,you' d better cut off the load of the UPS first.

5.4 Parameters inquiring

Press and hold the inquiring key  or  for more than half a second (less than 2 seconds) to inquire about items. The inquired items include input, battery, output, load, temperature. The displayed items on LCD screen are showed as following:

Output: Display the output voltage and output frequency of the UPS. As the following graphic shows, the output voltage is 220v, the output frequency is 50Hz.

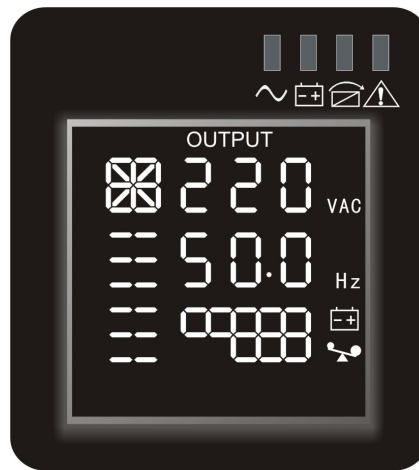

Load: Display the numerical value of the active power(WATT) and apparent power(VA) of the load. For example, as the following graphics shows: the WATT of the load is 100w, VA is 100VA (when disconnect load, it is a normal phenomenon to show a small numerical value of WATT and VA).

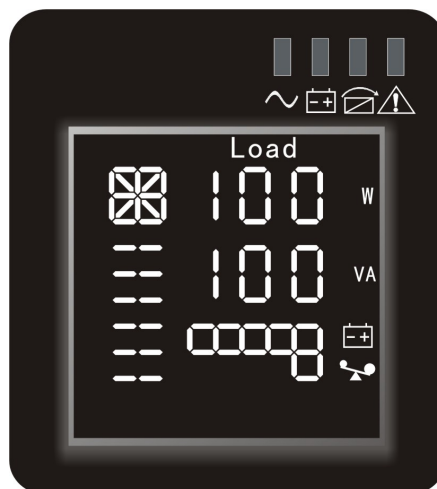

Temperature: Display the temperature of the inverter in the UPS. As the following graphics shows: the temperature of the inverter is 37°C.

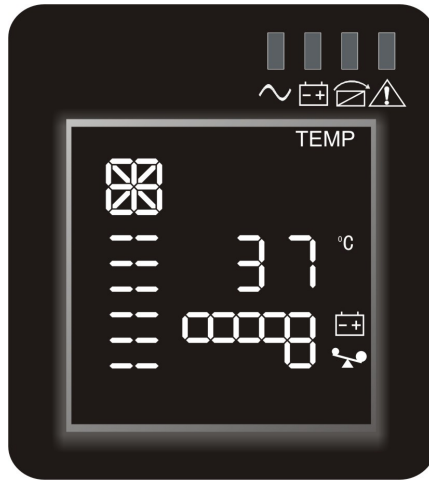

Input: Display the voltage and frequency of the input. As the following graphics shows: the input voltage is 210v, input frequency is 49.8Hz.

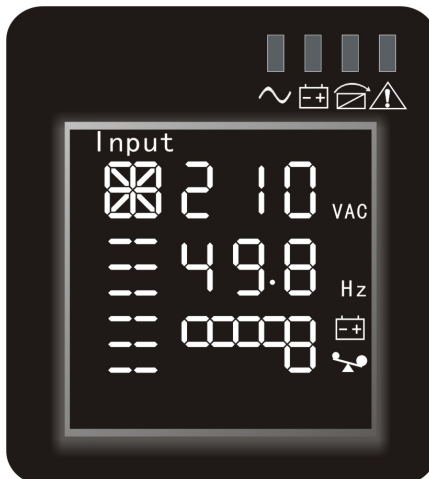

Battery: Display the voltage and capacity of the battery (determined by type). As the following graphics shows: the battery voltage is 28v, the capacity of battery is 100% (the capacity of battery is approximately reckoned according to the battery voltage).

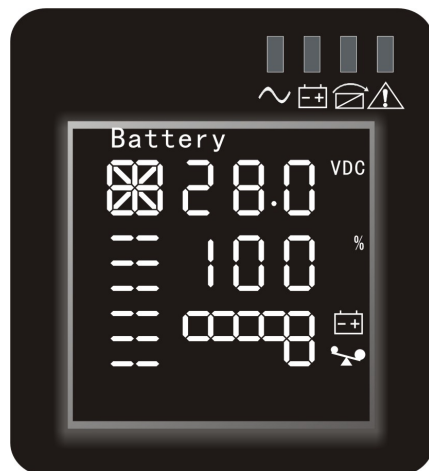

Press and hold the inquiring key  for more than 2 seconds, LCD begins to display the items circularly and orderly which transfer to another every 2 seconds. Press and hold the key for some time again, it will return to output status.

5.5 Run mode

5.5.1 Bypass mode

LED indications on front panel in bypass mode are as following:

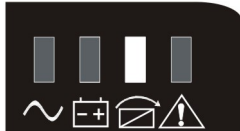

Bypass yellow LED is on, the buzzer beeps once every 2 minutes. The warning red LED is on when beeping. LCD displays are according to the exact load and battery capacity.

Turn to bypass mode under the following two conditions:

- ① Turn off the UPS in line mode while start the bypass output.
- ② Overload in line mode.

NOTE: When UPS is working in bypass mode, it has no back up function.

5.5.2 Line mode

LED indications on front panel in line mode are as following: the inverter green LED is on.

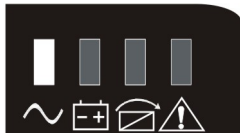

When input AC mains is in line with the working conditions, UPS will work in line mode.

5.5.3 Battery mode

LED indications on front panel in battery mode are as following: both the inverter green LED and battery yellow LED are on, the buzzer beeps once every 4 seconds. The warning red LED is on when beeping.

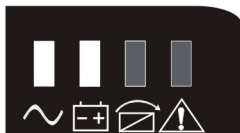

When the mains power down or instable, UPS will turn to battery mode at once. Continuously working on battery mode can last for 20 hours depending on the battery volume and the load. If battery discharge for 20 hours and the load is lower than 10% of rated power, the UPS will alarm for half an hour and then shutdown to protect the batteries.

5.5.4 ECO mode

LED indications on front panel on ECO mode are as following: both the inverter green LED and bypass yellow LED are on.

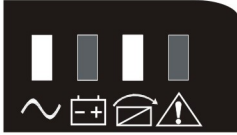

When the input mains meets the input range of the ECO mode and start the ECO function, the UPS will works on ECO mode. If input AC mains exceeds the range of ECO several times in a row in a minute but stays in inverting input range, UPS will work on inverting mode automatically.

5.5.5 Fault mode

LED indications on front panel in fault mode are as following:

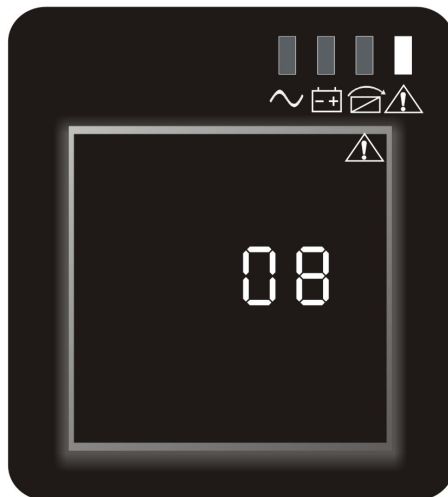

Fault mode (LCD interface on which the fault code display)
When UPS has fault, the fault LED lights and the buzzer beeps. UPS will turn to fault mode when overload fault, inverting fault and over-temperature fault happen. UPS cuts off the output and LCD display fault codes. At the moment, you can press the mute key to make the buzzer stop beeping temporarily to wait for maintenance. You can also press the ON/OFF key to shut down the UPS when confirm that there is no serious fault.

NOTE: As for corresponding information of the fault code, please refer to Fault Code information Table in Appendix.



NOTICE:

- ★ The following process must be performed if UPS is connected with generator:
- ★ First turn on generator, after it runs stably connect output power of generator to UPS input terminal, then turn on UPS. After UPS turned on, please connect load one-by-one.
- ★ It is recommended that the generator capacity is as twice as UPS rated capacity
- ★ You'd better not use the ECO mode when the quality of the input AC mains is not good.

6. Maintenance

Only minimum maintenance is required for this series of UPS. The battery is sealed lead acid maintenance free. It only needs to be kept charging to obtain the expected life. Whether it is started or not, the UPS would charge batteries once it is connected to mains and provide protection for over-charging and deep discharging.

6.1 Battery maintenance

1 It is recommended that the batteries are manually charged or discharged.

once every three or four months if UPS has not been used for a long time or the power is long-term uninterruptible. The battery will be fully discharge to low-voltage protection shutdown. Then it needs to be fully charged once.

2. In high temperature area, batteries should be manually charged and discharged once every two months. The process is the same as that said above.

3. Under normal circumstances of using, the battery working life is three to five years. If you find that the battery do not act well such as obviously shortening of backup time, too much imbalance on battery voltage so on, the battery should be replaced as soon as possible, which must be performed by qualified personnel.

4. When replace battery, it is recommended to change battery all together instead of changing separately.



NOTICE:

★Before replacing batteries, first please turn off the UPS and break off the mains. Remove your metallic adornment such as finger ring, watch and so on.

★When replace batteries, please use the screwdriver with insulating handle. Do not lay the tools or metallic goods on the battery.◦

★Never revert or short circuit between the battery anode and cathode.◦

7. Troubleshooting and performance of product

The following messages are the information that users would find on UPS when it meets some problems. Users can judge if the fault is caused by external factors and know how to deal with it by making full use of the information.

1. Fault indicator on, indicates that the UPS has detected some fault.
2. Buzzer beeps, indicates that UPS need to be paid attention to, if beeps for a long time, it means that there is something wrong with the machine.
3. If you need help, contact our service department, the following messages should be provided for analysis:
 - ◆UPS MODEL NO. and SERIAL NO.
 - ◆Date of fault happened
 - ◆Detailed description of the problem (include indicator statements on panel)

7.1 LED indication and warning table

Appendix1: Fault Codes

Fault causation	Fault Code
Bus Fault	00—19
Inverter Fault	20—39
Over Heat	40—44
Output short circuit	45—49
Overload	50—54
Output Relay Fault	55—59
Input NTC Fault	60—64
Auxiliary Power Fault	65—69
Input Fuse Fault	70—74
Others	99

Appendix 2: The corresponding working status of indications

NO	Working status	Indication				Warning	Remarks
		Nor	Bat	Bps	Fan		
1	Line mode						
	Normal voltage	•				None	
	High/low voltage protection, turn to battery mode	•	•		★	Once every four seconds	
2	Battery mode						
	Normal voltage	•	•		★	Once every four seconds	
	Battery Voltage abnormal warning	•	★		★	Once per second	
3	Bypass mode						
	Main AC Normal voltage in bypass mode			•	★	Once every two minutes	Eliminate after starting the UPS
	Main AC high voltage warning in bypass mode				★	Once every four seconds	
	Main AC low voltage warning in bypass mode				★	Once every four seconds	
4	Battery disconnect warning						
	Bypass mode			•	★	Once every four seconds	Affirm if the battery switch is closed
	Inverting mode	•			★	Once every four seconds	Affirm if the battery switch is closed
	Power up or start					Six times	Affirm if the battery is connected well
5	Output overload protection						
	Overload warning in line mode,	•			★	Twice per second	Remove the less important loads
	Overload in line mode, protection			•	•	Long beeps	Remove the less important loads
	Overload warning in battery mode	•	•		★	Twice per second	Remove the less important loads
	Overload in battery mode, protection	•	•		•	Long beeps	Remove the less important loads
6	Overload warning in bypass mode			•	★	Once every 2 seconds	Remove the less important loads
7	Fan fault (fan icon flash)	▲	▲	▲	★	Once every 2 seconds	Check if the fan is blocked by object.
8	Fault mode				•	Long beeps	If display fault code and icon▲lights, contact for maintenance when you can't deal with it by yourself.

- _indicator lights for a long time
- ★ _indicator flashes
- ▲ _the status of indicator depends on other conditions

Note: When UPS has fault, it is convenient for you to know the working status of UPS and the exact information about the fault promptly by referring to the two tables listed above.

7.2 Troubleshooting

When the fault occurs, firstly, perform troubleshooting by referring to the troubleshooting table. If the fault still exists, please contact the franchiser.

Fault	Cause	Solution
The “INPUT” letters on LCD display section flashes	The voltage or frequency of mains power exceeds UPS input range	UPS is working in battery mode, save disk and close the programs, make sure AC mains voltage and frequency is in the normal range
	Anti-connection of mains live and neutral	Re-connect the input power cable and make a correct connection
Battery capacity indicator flashes	Battery low voltage or battery disconnected	Check UPS battery, connect battery well, if battery damaged, replace it
Mains normal, but UPS has no input	UPS input breaker open circuit	Press the breaker for reset
Short back up time	Battery not fully charged	Keep UPS connecting with mains power for more than 8 hours, recharge battery
	UPS overload	Check the usage of loads, remove some redundant devices
	Battery aged	When replace battery, contact franchiser to get battery and relative assembly
UPS doesn’ t startup after pressing the ON key	Short holding time	Press and hold the ON key for more than 1s to start UPS
	UPS has no battery connected or battery voltage low and too many loads connected	Connect UPS battery well, if battery voltage low, please turn off UPS and take off some loads, then start UPS
	Fault occurs inside UPS	Contact supplier for servicing
The icon of charger status on LCD display flashes and buzzer beeps once per second	Charger doesn’ t work normally or battery aged	Contact supplier for servicing

7.3 EMC standard/Safety standard

◆Our product are manufactured according to the following EMC international grade standard and has passed the CE authentication:

EMC standard number	Safety standard number
IEC62040-2	IEC62040-1
IEC61000-4-2	GB4943-2005
IEC61000-4-3	
IEC61000-4-4	
IEC61000-4-5	

7.4 Product Performance

7.4.1 Electric performance

Model		RT 1250VA	RT 1250VA (H)	RT 2000VA	RT 2000VA (H)	RT 3000VA	RT 3000VA (H)	
Rated capacity		800W/1000VA		1600W/2000VA		2400W/3000VA		
input	input	Single phase and earthing						
	Voltage range	115±5VAC-295±5VAC						
	Frequency	45Hz-55Hz@50Hz/55Hz-65Hz@50Hz						
	Power factor	≥0.98						
	ECO range	setting rated output voltage ±20VAC						
	Bypass range	186VAC-252VAC						
output	Output style	Single phase and earthing						
	Rated voltage	208/220/230/240VAC						
	Power factor	0.8						
	Voltage precision	±2%						
	Output Fre- quency	Line mode	1、When input frequency is in the range, the output frequency is the same as that of input. 2、When input frequency is out of the range, the output frequency of output is (50/60±0.2)Hz					
		Battery	(50/60±0.2)Hz					
	Crest ratio	3: 1						
	Transfer time	mains←→battery =0ms						
		mains←→bypass <4ms						
	Overload capacity	Battery mode	108%±5%<load≤150%±5% >30s cut off output and warn, 150%±5%<load<200%±5% > 300ms cut off output and warn					
		Line mode	108%±5%<load≤150%±5% > 30s transfer to bypass and warn 150%±5%<load<200%±5% >300ms transfer to bypass and warn					
	efficiency	mains	Full load≥87%		Full load≥88%			
battery		Full load≥85%						
ECO		Full load≥94%						

battery	Input battery voltage	24VDC	24VDC	48VDC	48VDC	72VDC	72VDC
	Internal battery	2		4		6	
	Internal battery type	12V/9AH high-rate sealed lead acid maintenance free battery (only refers to standard UPS)					
	Backup time	Full load \geq 5min (only refers to standard UPS) , As for long backup UPS, the backup time is determined by the capacity of battery.					
	Charge current (A)	1	7/14	1	7/14	1	7/14

NOTE: The rated output voltage has been already provided. The function of setting the rated output voltage by LCD menu is an optional.

◆ Work Environment

Model	RT 1250VA(S/H), RT 2000VA(S/H), RT 3000VA(S/H) series
Temperature	0°C~40°C
Relative humidity	0~95% non-condensing
Altitude	<1500m. when >1500m, lower the rated power for use
Store temperature	-25°C~55°C

◆ Mechanical Specification

Model	Dimension W*D*H (mm)	Net weight/Gross weight (kg)
RT 1250VA	440*380*86.5	12/14.5
RT 1250VA(H)		7/9.5
RT 2000VA	440*520*131	21.5/24.3
RT 2000VA(H)		11.5/14.3
RT 3000VA		26/28.8
RT 3000VA(H)		11.7/14.5

7.5 Communication interface

7.5.1 RS232 communication interface

This UPS provides a standard DB9 communication interface on its rear panel, the definition of the pins is as following:

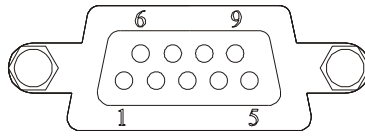

Pin	Definition
1、4、6、7、8、9	No use
2	Transmit
3	Receipt
5	GND

7.5.2 RS232 cable specifications

When connecting the UPS with PC by RS232 cable, it needs to use the standard RS232 cable, the detailed cable NO. are as following:

PIN 1 (hole) to computer serial port	PIN 2(needle)to UPS serial port
2	2
3	3
5	5

7.5.3 Optional communication interface

① USB communication interface

USB communication interface: Install the intelligent monitoring software UPSilon2000 which is equipped with the UPS. Then it can achieve the communication with monitoring device directly. When RS232 and USB are provided, only one of them will be chosen and USB is preferred.

② Intelligent slot

The following intelligent cards can be installed into the intelligent slot of the UPS: intelligent USB card, intelligent SNMP card and intelligent dry contact card. Support the hot plug and play. Any card of them can be used according to users' requirements.

- Intelligent USB card: Use the monitoring function of the USB interface system to monitor and manage the power source of the UPS.
- Intelligent SNMP card: When connecting to the internet by SNMP card, it communications with the monitoring computer to monitor power source of the UPS from far end.
- Intelligent dry contact card: Use the monitoring function of the dry contact interface system to monitor and manage the power source of the UPS.

NOTE:

Remove the cover before installing the optional accessories.

The operating instruction of the UPSilon can be acquired from the CD.

As for the operating instructions of the intelligent USB card, SNMP card and dry contact card, please refer to the relative special instructions.

